

MSC1201/02EVM User's Guide

MSC1201/02 Precision ADCs with 8051 Microcontroller and Flash Memory Evaluation Module

This user's guide describes the function and operation of the MSC1201/02EVM evaluation module. This manual will help you quickly set up the EVM and its accompanying software, so that you can rapidly test and evaluate the MSC1201 and the MSC1202. For a more detailed description of the MSC1201 or the MSC1202, please refer to the product datasheets available from the Texas Instruments web site at <http://www.ti.com>. Additional support documents are listed in the section of this guide entitled **Related Documentation from Texas Instruments**. Throughout this document, the abbreviation *EVM* and the phrase *evaluation module* are synonymous with the MSC1201/02EVM. A complete circuit description is included, as well as schematic diagrams and bill of materials.

Contents

1	Introduction	2
2	Getting Started	5
3	EVM Operation.....	9
4	Physical Description	16
Appendix A	Certificate of Conformity	23

List of Figures

1	MSC1201/02EVM Overview	3
2	Installation Screen	6
3	Keil uVision2 Display Screen	7
4	Options for Target (Output).....	8
5	MSC1201/02EVM Processor and Analog Inputs	17
6	MSC1201/02EVM Power and Communications Selection	18
7	MSC1201/02EVM Layout	19

List of Tables

1	Factory Jumper Settings.....	5
2	Jumper and Function Reference	9
3	J1: USB Port Pinout	12
4	J3: RS-232 Port Pinout.....	12
5	J2: Unregulated Power Input Connector	13
6	JMP1: 5V Power Source Select.....	13
7	JMP2: DV _{DD} Power Source Select.....	14
8	JMP5: AV _{DD} Power Source Select.....	14
9	J13: Analog Inputs	14
10	TP1–6: Test Points.....	15
11	MSC1201/02EVM Bill of Materials	20

1 Introduction

This User's Guide gives a general overview of the MSC1201/02EVM and software, and provides a general description of the features and functions to be considered while using this device.

1.1 MSC1201/02 Device Characteristics

The MSC1201 and MSC1202 are precision 24-bit delta-sigma ($\Delta\Sigma$) analog-to-digital converters with an 8051 microcontroller and up to 8K of flash memory. Both have eight differential or single-ended analog input channels. The delta-sigma architecture employed in the MSC1201/02 enables the devices to achieve 22 bits of effective resolution (0.45ppm RMS noise) at a data rate of 10Hz. They can be programmed for other data rates over 1kHz that have lower effective resolution. In addition to the standard 8051 peripherals and functions, the MSC1201/02 include a 32-bit accumulator, a basic SPI[®]/I²C[®] interface, 16-bit PWM output, up to 5K of data flash memory, 256 bytes of data RAM, UART and dual DPTR registers.

The MSC1201/02 has an enhanced 8051 core which only requires four clock cycles per machine cycle. It has extra timers as well as watchdog, brownout and low voltage detect circuits; additionally, the device has power management control and hardware breakpoint registers.

SPI is a registered trademark of Motorola, Inc.

I²C is a registered trademark of Royal Philips Electronics B.V., The Netherlands.

1.2 EVM System Overview

A block diagram of the MSC1201/02 evaluation module is shown in Figure 1.

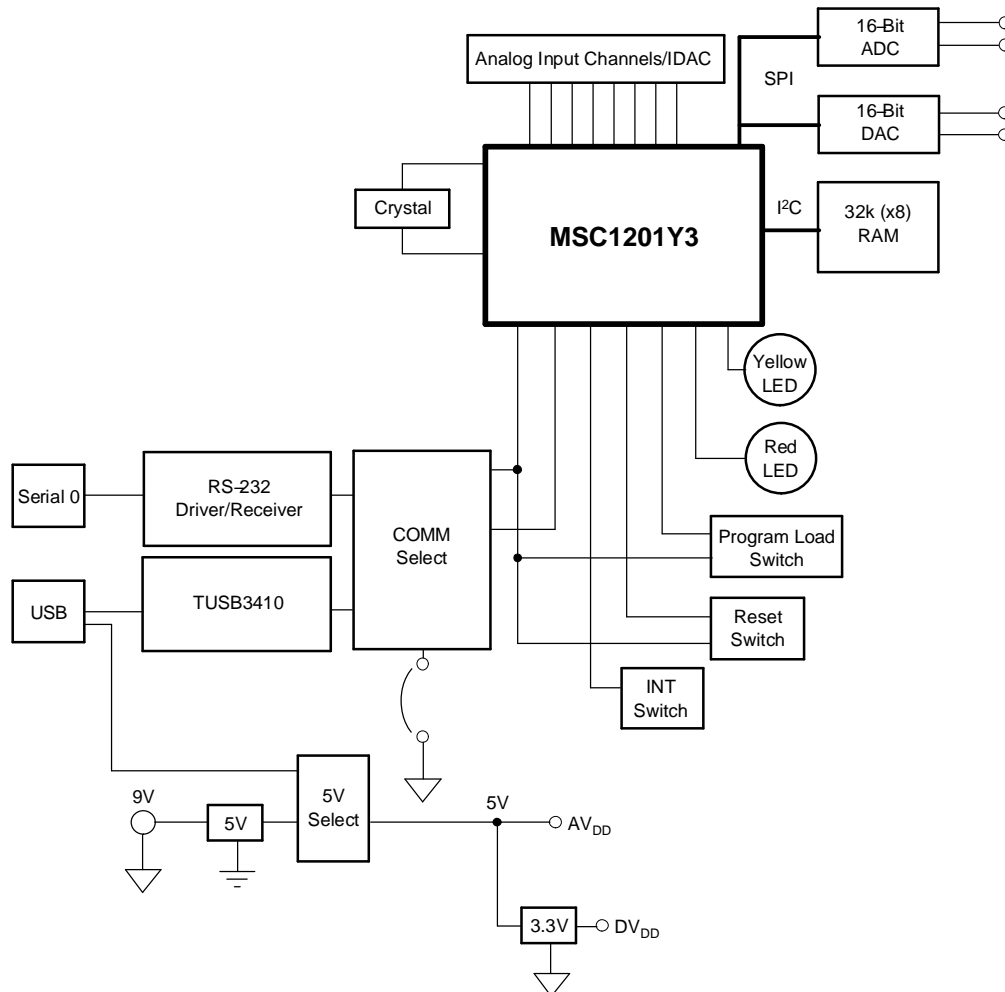

Figure 1. MSC1201/02EVM Overview

During normal operation, programs are developed on the PC and then downloaded into the MSC1201/02 for execution. The primary development environment is Raisonance or Keil for assembly and C language programming.

1.3 Analog Inputs

Analog input is supplied through the 9-way screw terminal block J4 and the two-way terminal J8. The seven analog inputs (AIN0-5, AINCOM) are connected to the MSC1201/02 through a 100Ω resistor. There is also a terminal block for AGND (GND) and IDAC output. The inputs have only the 100Ω resistor to protect against overvoltage.

1.4 Power Requirements

When the MSC1201/02EVM uses J3 (RS-232) connector for communications, power (5.5V to 15V) must be supplied to J2 and a jumper must be uninstalled on JMP14. Additionally, JMP1 would connect pins 2-3 for proper operation.

A 9V wall mount power supply is included with the MSC1201/02EVM to provide this power.

When using USB communications, power is provided from the USB connector (J1); pins 1-2 are connected on JMP1 and the jumper on JMP14 is installed.

Power can also be provided from the USB source with communications using the RS-232 connector. In such a case, JMP1 would connect pins 1-2 and JMP14 would be uninstalled.

1.5 Host Computer Requirements

The Keil or Raisonance software development environments are designed to run on a PC that is using any Microsoft Windows™ platform (Windows 9x/NT/2K/XP).

Minimum operating system requirements are:

- IBM-compatible 486 PC or higher
- 64MB RAM
- 20MB available hard disk space
- CD-ROM drive
- Available RS-232 or USB serial port

1.6 Related Documentation from Texas Instruments

The following documents provide information regarding Texas Instrument integrated circuits used in the assembly of the MSC1201/02EVM. The latest revisions of these documents are available from the TI web site at <http://www.ti.com>.

Data Sheet	Literature Number
MSC1201	SBAS317
MSC1202	SBAS328
REG102NA-5, REG102NA-3.3	SBVS024
TUSB3410VF	SLLS519
MAX3243CPWR	SLLS350
TPS3837L30DBVT, TPS3838L30DBVT	SLVS292
DAC8531E	SBAS192
ADS8325IBDGKT	SBAS226
SN74AHC1G07DBVR	SCES296

2 Getting Started

This section will guide you through unpacking the EVM and setting it up so that you can begin working with it immediately.

2.1 Unpacking the EVM

After unpacking the MSC1201/02EVM kit, verify that you have received all of the items listed here:

- MSC1201/02EVM board
- 9V wall mount power supply, with international connectors
- 9-pin D-sub male-female 2m serial cable
- 2m A-B USB cable
- Software CD-ROM
- This user's guide (on the CD-ROM)

If any of these items are missing, contact Texas Instruments to receive a replacement.

2.2 Default Configuration

Although much of the MSC1201/02EVM operation is controlled by the host PC, some configuration must be done directly on the board, using ten jumpers (shorting blocks). The MSC1201/02EVM is configured at the factory as described in [Table 1](#).

Table 1. Factory Jumper Settings

Jumper Identifier	Description	Default Setting
JMP1	5V power supply source (U1)	2-3
JMP2	Digital power supply select (5V)	2-3
JMP3	USB reset	Open
JMP4	IDAC 1K load resistor	Open
JMP5	AV _{DD} power source (5V)	1-2
JMP6	AINCOM to AGND connection	1-2
JMP7	Red LED enable	1-2
JMP8	Yellow LED enable	1-2
JMP9	DIN SPI/I ² C select (SPI)	1-2
JMP10	SPI/I ² C clock source (SPI)	1-2
JMP11	External reference input	Open
JMP12	REF- to AGND	1-2
JMP13	DOUT SPI/I ² C select (SPI)	2-3
JMP14	RS232/USB communications (RS-232)	Open

For more information about the jumpers, see [Section 3.1](#).

2.3 Quick Start Guide

Once the MSC1201/02EVM has been unpacked from its shipping container, and you have verified that the board is configured as shown in [Table 1](#), it can be powered on and tested.

2.3.1 USB Connection

Connect the board to the host PC using the supplied USB serial cable. When the board is properly powered on, the green *power-good* LED near the power USB connector will glow brightly.

2.3.2 Wall Mount Power Connection

Connect the board to the host PC using the supplied 9-pin D-sub serial cable. Then power on the board by plugging the wall power adapter into a suitable AC power source and inserting the barrel plug into the barrel jack on the MSC1201/02EVM. (You do not have to connect the serial cable first; it is safe to apply power to the board first.) When the board is properly powered on, the green *power-good* indicator lamps near the USB connector will glow brightly.

Place the CD-ROM into your PC CD-ROM drive. You should then see a screen display similar to the installation screen shown in [Figure 2](#).

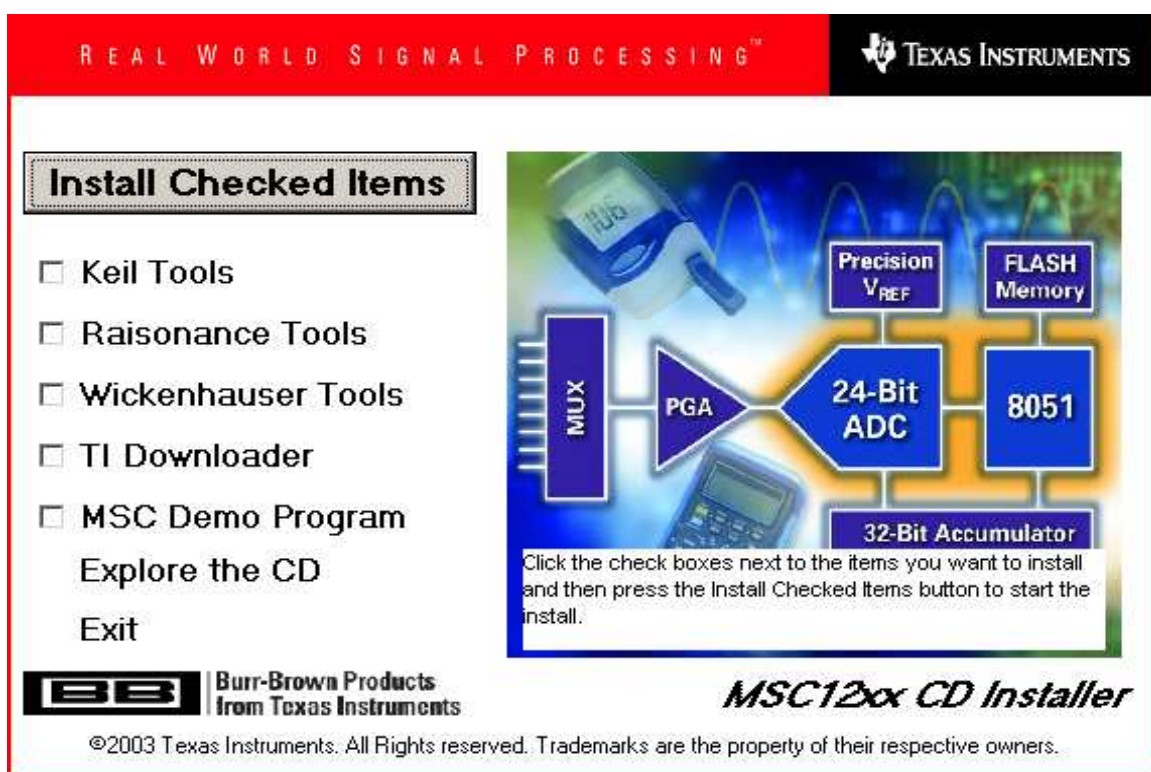

Figure 2. Installation Screen

Select the tools that you want to install. Keil, Raisonance and Wickenhauser are all C compilers. The Keil and Raisonance tools include a complete integrated development environment (IDE) with debug support. The TI Downloader is used to load the compiled HEX file into the MSC1201/02EVM.

Install any (or all) of the compilers that you wish to use. Also, choose the TI Downloader. (**Note:** If you are running Windows NT or Windows 2000, you will need administrator privileges in order to install the software.) Follow the instructions provided by the installer. When the software is installed you can select **Explore the CD**, and find some example programs in the **Example Programs\MSC1200 Examples** directory.

Once the programs have been successfully installed, you can execute them. If you examine the **MSC1200 HelloWorld** directory, you will see project files for both Keil (HelloWorld.Uv2) and Raisonance (HELLOWORLD.PRJ). If you have installed both compilers, you can double-click on either project file and it will open up the appropriate IDE.

When the Keil uVision2 development system is run, it will display a title screen; you will then see a screen like that shown in [Figure 3](#).

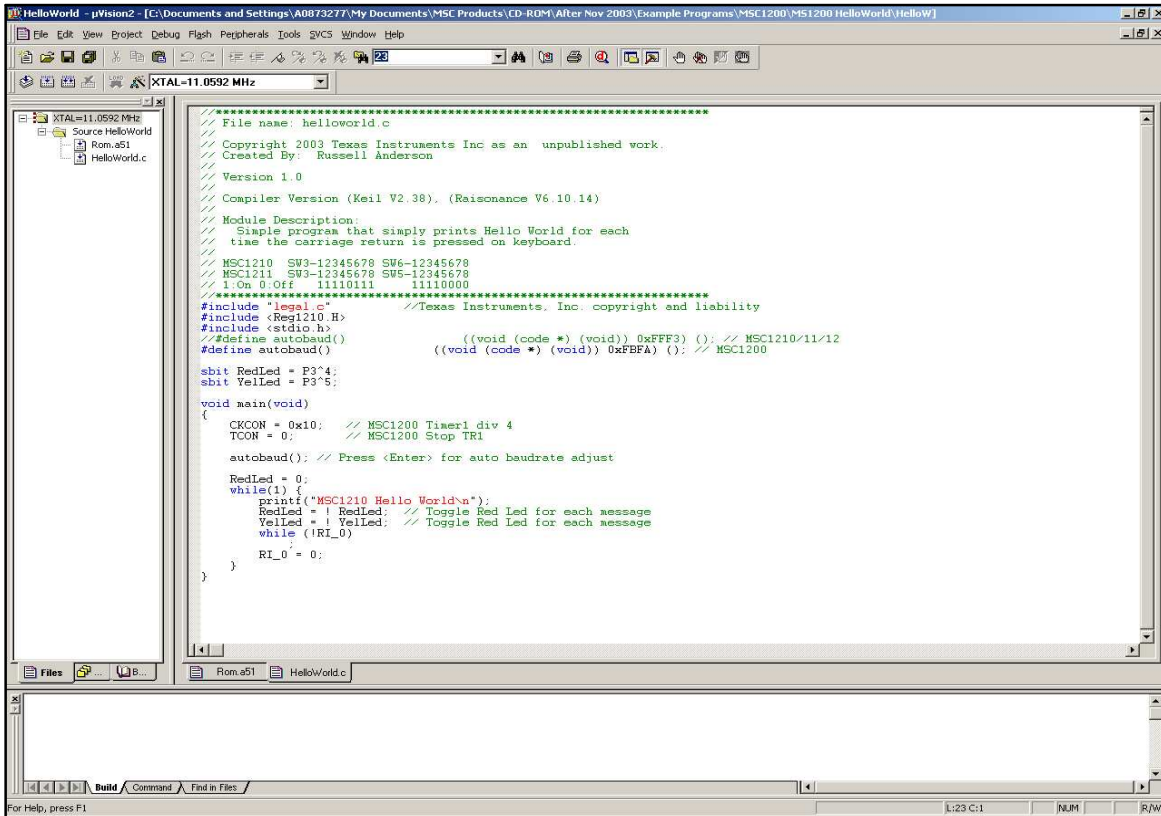

Figure 3. Keil uVision2 Display Screen

Refer to the Keil documentation and Help menus for more information about how to interact with the Keil environment. When a program is compiled, it can be immediately downloaded into the MSC1201/02EVM by using the TI download utility program.

In the Project Menu, select **Options for target '...'** Then select the **Output** tab. (Or, click on the magic wand, then select the **Output** tab.) You will see a screen like the one shown in [Figure 4](#).

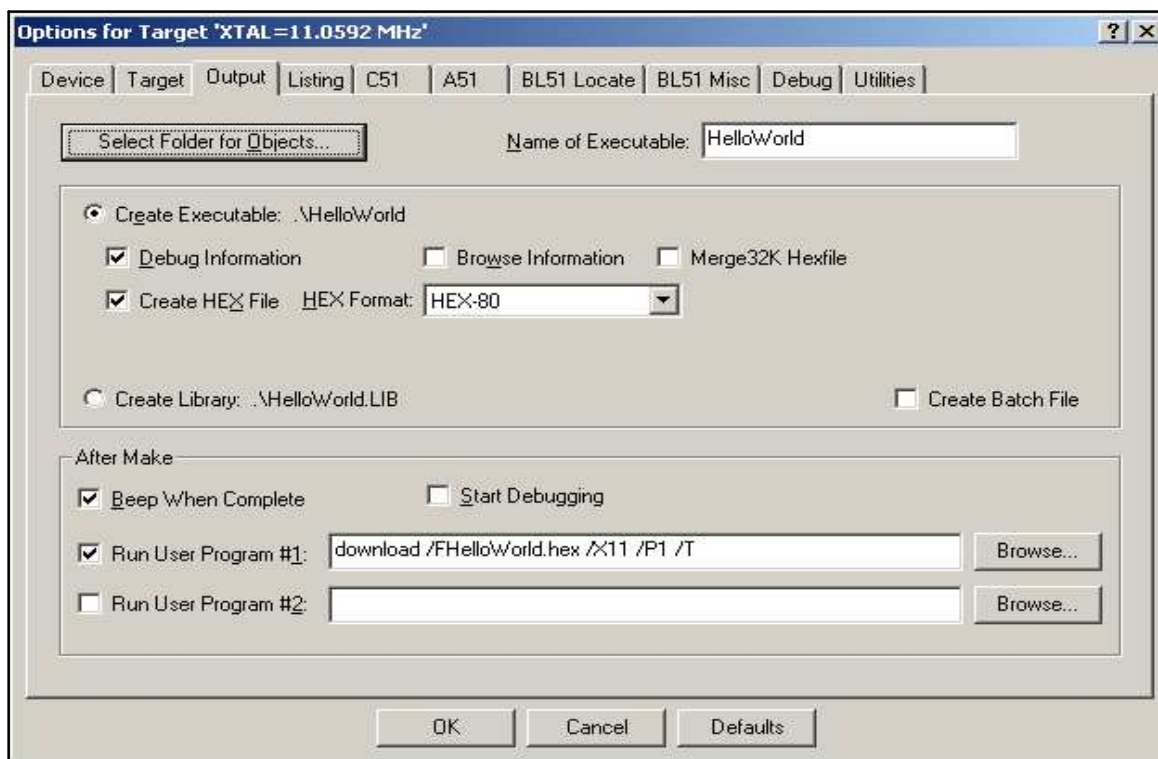

Figure 4. Options for Target (Output)

Check the box to **Create HEX File** and **Run User Program #1**. Then enter the download command with its parameters in the window. The **download.exe** file will need to be in the current directory or the Windows path.

All operands should immediately follow the switch character with no spaces except between options. For example:

- download.exe /Fconv.hex /B9600 /P1

If the filename, crystal frequency or port are not included, then a display screen will prompt you for the values.

- /File (*required*) hex file; #H in the Keil environment will substitute the hex file.
- /Xfreq (*required*) MSC1201/02 Xtal Clock frequency
- /Pport (*required*) PC Comm Port 1, 2, 3 or 4
- /Bbaud Download baud rate (standard rates); otherwise, computed from /Xfreq
- /H If this flag is present, the configuration bytes will be erased
- /Tbaud This flag requests a terminal window after download; can specify baud.
- /D Debug mode. Displays a terminal window of the command interactions.
- /Epages Specify a partial erase of the flash memory.
- /M Pause for the MSC1201/02 to be manually reset into programmable mode.

3 EVM Operation

This section describes each function of the MSC1201/02EVM, as well as how to use the accompanying software to program and use the MSC1201/02.

3.1 Jumpers

Table 2 shows a detailed summary of each jumper on the MSC1201/02EVM.

Table 2. Jumper and Function Reference

Reference Designator	Setting/Pin	Function	Default	Subsection (for more information)
JMP1	1 to 2	5V is supplied by USB	1-2	Section 3.1.1
	2 to 3	5V is supplied by U1 from J2		
JMP2	1 to 2	3.3V DV _{DD}	2-3	Section 3.1.2
	2 to 3	5V DV _{DD}		
JMP3	1	AGND	Disconnected	Section 3.1.3
	2	$\overline{\text{RESET}}$ for U3 (TUSB3410)		
JMP4	1	R15 – 1K Resistor to AGND	1-2	Section 3.1.4
	2	IDAC		
JMP5	1	+5V	1-2	Section 3.1.5
	2	R18 – 10 Ω to AV _{DD} (MSC1201/02)		
JMP6	1	AGND	1-2	Section 3.1.6
	2	AINCOM		
JMP7	1	P3.4/T0	1-2	Section 3.1.7
	2	LED D5 connected to R13 to DV _{DD}		
JMP8	1	P3.5/T1	1-2	Section 3.1.8
	2	LED D6 connected to R13 to DV _{DD}		
JMP9	1	DO _{UT} U13 (ADS8531) [SPI]	1-2	Section 3.1.9
	2	P1.3/DIN		
	3	SDA U12 (MCP_24LC256) [I ² C]		
JMP10	1	SCLK (U11), DCLK (U13) [SPI]	1-2	Section 3.1.10
	2	P3.6/SCK		
	3	SCL (U12) [I ² C]		
JMP11	1	V _{REF} input to REFOUT/REFIN+ U8	Disconnected	Section 3.1.11
	2	AGND		
JMP12	1	REFIN- U8 AGND	1-2	Section 3.1.12
	2	AGND		
JMP13	1	SDA U12 (MCP_24LC256) [I ² C]	2-3	Section 3.1.13
	2	P1.2/DO _{UT}		
	3	DIN U11 (DAC8531) [SPI]		
JMP14	1	R4 – 10K to 3.3V (RS-232 signal select)	Disconnected	Section 3.1.14
	2	AGND		

3.1.1 JMP1: 5V Power Source Select

The MSC1201/02EVM can use either the USB connection or the voltage regulator U1 for the source of +5V. Shorting pins 1 and 2 connects a filtered version of the 5V power from the USB source. Shorting pins 2 and 3 connects the 5V signal to the output of the voltage regulator U1.

3.1.2 JMP2: DV_{DD} Power Source Select

The MSC1201/02 have separate analog and digital power supplies. Use JMP2 to connect the desired voltage source for the digital power supply DV_{DD}. Shorting pins 1 and 2 connects DV_{DD} to the onboard 3.3V regulator; shorting pins 2 and 3 connects DV_{DD} to 5V.

3.1.3 JMP3: TUSB3410 $\overline{\text{RESET}}$ Pin

JMP3 provides a method to reset the TUSB3410. Shorting pin 1 to 2 resets U3 (TUSB3410).

3.1.4 JMP4: Enable Voltage Output for IDAC

If a jumper is between pins 1 and 2 of JMP4, a 1K resistor is connected from the output of the IDAC to AGND. This connection provides a method to convert the current from the IDAC pin to a voltage.

3.1.5 JMP5: AV_{DD} Power

If a jumper is between pins 1 and 2 of JMP5, the 5V that is derived from either the USB or the regulator IC U1 will be filtered and used for the AV_{DD} power. If another source of AV_{DD} voltage is desired, then the jumper can be removed and the voltage applied between pin 2 and AV_{DD}.

3.1.6 JMP6: AINCOM to AGND

By shorting the two pins of JMP6, the AINCOM signal will be connected to AGND.

3.1.7 JMP7: Red LED Enable

When this jumper is inserted, the Red LED D5 is connected to port pin 3.4. The other side of D5 is connected to a 220 Ω resistor which connects to the DV_{DD} voltage. This 220 Ω resistor provides the current limiting when the P3.4 is output as a low voltage.

3.1.8 JMP8: Yellow LED Enable

When this jumper is inserted, the Yellow LED D6 is connected to port pin 3.5. The other side of D6 is connected to a 220 Ω resistor which connects to the DV_{DD} voltage. This 220 Ω resistor provides the current limiting when the P3.5 is output as a low voltage.

3.1.9 JMP9: SPI/I²C Data Connection

When pins 1 and 2 are connected, the DIN pin of U8 is connected with the DOUT pin of U13 for SPI data communications with the 16-bit ADC (ADS8325). With the jumper on pins 2-3, the DIN signal from U8 is connected to pin 1 of JMP11 so that it can be connected to DOUT for I²C operation.

3.1.10 JMP10: SPI/I2C Clock Select

When pins 1 and 2 are connected, the clock signal (P3.6/SCK) is connected to the SPI devices. When pins 2 and 3 are connected, the clock signal is connected to the I²C memory device.

3.1.11 JMP11: External Reference Positive Input

A single-ended reference can be connected between pin 1 (positive) and pin 2 (AGND) for use by U8. This assumes that JMP12 is installed.

3.1.12 JMP12: External Reference Negative Input

For normal operation, this jumper will be installed so that REFIN⁻ will be connected to AGND. JMP12 can also be used in combination with JMP11 for a differential reference. A differential reference can be applied to pin 1 of JMP11 (positive) and pin 2 of JMP12 (negative).

3.1.13 JMP13: SPI/I2C Clock Select

When pins 1 and 2 are connected, the DOUT pin of U8 is connected to the DIN/DOUT signal for I²C operation with U12, the I²C memory. When pins 2 and 3 are connected, the DOUT pin of U8 is connected to the DIN pin of the DAC8531 (U11).

3.1.14 JMP14: RS-232 Communication Selection

When JMP14 is installed, the RS-232 communications are directed through the USB port. The DB9 connector J3 is used for RS-232 communication when JMP14 is removed.

3.2 INT Switch

Switch SW2 is a miniature pushbutton which, when pressed, shorts Port 3.2 to ground (through a 1K resistor). This pin is the $\overline{INT0}$ pin and can therefore be set up to cause an interrupt when this pin goes low.

3.3 Reset Switch

Switch SW1 is a miniature pushbutton which, when pressed, forces the MSC1201/02 RST line high. When released, the MSC1201/02 will enter a reset cycle. If communications become disrupted between the host and the board, or if the board is unresponsive, pressing RESET will return the system to normal operation.

3.4 PRG LD Switch

Switch SW3 is a miniature pushbutton which, when pressed, forces the MSC1201/02 RST line high. It also pulls the Port 1.0 line low so that when RST ends, the MCU will enter the Program Load mode. Program execution will be from the on-chip ROM; it starts first by waiting for a carriage return so that it can perform an autobaud function. This mode is used to load a hex file into the flash memory for later execution.

3.5 I/O Connectors and Signals

This section describes the various connectors on the MSC1201/02EVM.

3.5.1 J1: USB Type B Connector

This connector routes the USB signals to U3, where they are converted to RS-232 signals for communication with the MSC1201/02 (U8). All of the same modes of operation are available through the USB, so program loading and communication can occur via USB. JMP14 determines whether RS-232 communication uses USB (J1), with JMP14 on, or J3, with JMP14 off.

Table 3 describes the J1 USB port pinout configuration.

Table 3. J1: USB Port Pinout

Pin Number	Signal Name	USB Name	Direction (at board)	Function
1	GND	Power Ground	Input	Ground return for VCC power
2	D-	USB data pin Data-	Bidirectional	USB data
3	D+	USB data pin Data+	Bidirectional	USB data
4	VCC	+5V Power	Input	+5V power (500mA max)

3.5.2 J3: Serial RS-232 Connector

The host PC can communicate with the MSC1201/02EVM via this connector, which is a 9-pin female D-shell type, pinned out in the usual manner. Certain of the flow control lines are used for special purposes by the MSC1201/02EVM board; these particular lines are described in Table 4. The host communication uses J3 or J1 depending on JMP14.

Table 4. J3: RS-232 Port Pinout

Pin Number	Signal Name	RS-232 Name	Direction (at board)	Function
1	DCD	Data Carrier Detect	Output	None
2	RD	Receive Data	Output	Serial data output to host PC
3	TD	Transmit Data	Input	Serial data input from host PC
4	DTR	Data Terminal Ready	Input	Connected to the reset circuit. A low to high transition on this line resets the MCU.
5	SG	Signal Ground	Power	Ground reference
6	DSR	Data Set Ready	Output	None
7	RTS	Request To Send	Input	Connected to PROG LOAD function. Used to enter serial programming mode. A high-to-low transition resets the MCU and puts it into the serial programming mode.
8	CTS	Clear To Send	Output	None
9	RI	Ring Indicator	Output	None

In the RS-232 electrical specification, $-5V$ to $-15V$ on a line indicates a logic *high* (mark), and $+5V$ to $+15V$ indicates a logic *low* (space). Line states are described here according to their logical states.

If a non-handshaking RS-232 cable is used – one which connects only RD, TD, and signal ground – the board can still operate normally; however, it cannot be reset by the host PC, and bootstrap firmware upgrading cannot be performed through the serial port unless commands are defined in the User Application program.

3.5.3 J2, JMP1, JMP2, JMP5: Power Connectors

The MSC1201/02EVM features a flexible power supply system. External power supplies, USB, the on-board regulator circuitry and/or the supplied wall mount adapter may all be used in some combinations to supply power to the EVM. Furthermore, the separate analog and digital power supplies may be powered differently; for example, the analog power supply may be powered externally, and the digital power supply may use the onboard regulator, at the same time. (This is configured using jumpers JMP2 and JMP5.)

The analog power AV_{DD} is always 5V from either the regulator U1 or from a filtered version of the USB power, although external power could be applied to pin 2 of JMP5 to provide any desired AV_{DD} voltage from 2.7V to 5.25V with the ground connected to TP1 (AGND).

The digital power DV_{DD} is supplied from pin 2 of JMP2. If connected to pin 1, then DV_{DD} will be 3.3V from voltage regulator U2. If pin 2 of JMP2 is connected to pin 3, then DV_{DD} is the 5V at the input of U2. This 5V can come from either the output of U1 or the USB; or, it could be supplied from an external supply voltage to the center pin of JMP1. Pin 2 of JMP2 could also be supplied from an external supply voltage with the ground connected to TP2.

CAUTION

Be very careful when connect external power supplies to JMP5, JMP2 and JMP1. They are not protected against reversed polarity. If you connect them backwards (that is, with reversed polarity), it is likely that the MSC1201/02EVM will be permanently damaged.

Table 5 through Table 8 summarize the power options for the MSC1201/02EVM.

Table 5. J2: Unregulated Power Input Connector

Terminal Name	Function
tip	Positive power supply input
Sleeve	Power ground

Table 6. JMP1: 5V Power Source Select

Terminal Name	Function
1	USB power
2	5V for U2, AV_{DD} or DV_{DD}
3	U1 voltage regulator output

Table 7. JMP2: DV_{DD} Power Source Select

Terminal Name	Function
1	3.3V from voltage regulator U2
2	DV _{DD}
3	5V from JMP1 pin 2

Table 8. JMP5: AV_{DD} Power Source Select

Terminal Name	Function
1	5V from JMP1 pin 2
2	AV _{DD} to U8 through R18 & (C27,C28)

3.5.4 J4: Analog Inputs, IDAC Output

Terminal block J4 is the main analog input to the MSC1201/02EVM. One terminal is provided for each of the nine differential inputs on the MSC1201/02. Each terminal is connected to the MSC1201/02 through a 100Ω resistor.

Table 9 summarizes the analog inputs for the MSC1201/02EVM.

Table 9. J13: Analog Inputs

Terminal Number	Terminal Name	MSC1201/02 Pin Number	Function
1	AIN0	24	Analog Input 0
2	AIN1	23	Analog Input 1
3	AIN2	22	Analog Input 2
4	AIN3	21	Analog Input 3
5	AIN4	20	Analog Input 4
6	AIN5	19	Analog Input 5
9	AINCOM	12	Analog Common
10	AGND	10, 11	Analog Ground
11	IDAC	13	IDAC Output

3.5.5 TP16: Reference Output/Input

The MSC1201/02EVM has an onboard 2.5V/1.25V bandgap reference. If a lower-noise reference source or a reference with a different voltage is desired, it can be connected to test point JMP12 (or test points JMP12 and JMP13). When using an external reference, the internal reference should be shut off (using ADCON0) since they use the same pin. C37 and C32 provide bypassing for the Reference Inputs.

3.5.6 TP1-6: Test Points

The test points (summarized in Table 10) can be used to monitor certain signals on the board.

Consult the MSC1201/02 datasheets for information on the signals connected directly to the MSC1201/02.

Table 10. TP1–6: Test Points

Test Point Designator	MSC1201/02 Pin Number	MSC1201/02 Pin Name	Signal Description
TP1	10, 11	AGND	Analog Ground
TP2	33, 34, 38	DGND	Digital Ground
TP3	-	100kΩ Pullup	Uncommitted
TP4	-	100kΩ Pullup	Uncommitted
TP5	-	X1/CLK1	Clock Input for TUSB3410 (U3)
TP6	2	XIN	Clock input for MSC1201/02 (U8)
AIN5	19	AIN5	Analog input 5
AIN4	20	AIN4	Analog input 4
AIN3	21	AIN3	Analog input 3
AIN2	22	AIN2	Analog input 2
AIN1	23	AIN1	Analog input 1
AIN0	24	AIN0	Analog input 0
TP14	5	RST	Reset for MSC1201/02 (U8)
VREF	14	REFOUT/REFIN+	Internal Reference Output or Positive Reference Input

3.6 Circuit Description

The MSC1201/02EVM combines the MSC1201/02 microcontroller, 24LC256 32Kx8 EEPROM, DAC8531, ADS8325, a 22.11842MHz crystal, support for one serial port, and other support circuits to aid in the evaluation of the MSC1201/02. In addition, the TUSB3410 microcontroller is included so that the MSC1201/02 serial communications can come via either RS-232 or USB.

3.6.1 MSC1201/02

The MSC1201/02 (U3) is clocked by the internal oscillator or a 22.1184MHz crystal. Analog inputs come from J4 through current-limiting resistors RA2.

Programs can be loaded into the 8K bytes of flash memory using the serial port (RS-232 or USB). The MSC1201/02 has 256 bytes of RAM on-chip.

For detailed information about the MSC1201/02, consult the MSC1201/02 product datasheets.

3.6.2 Programming and Host Communication

The Keil or Raisonance integrated software environments, combined with the TI Downloader program, provide a convenient system of program development, download and execution.

Full source code for the MSC1201/02EVM test firmware is included on the CD-ROM.

3.6.3 Power Supply

Power is brought into the board through external power connectors J2, the USB, or to the individual pins on JMP1, JMP2 or JMP5. If JMP14 is installed, the USB communications are enabled.

Power supplied through J2 is regulated by voltage regulators U1 and U2, which provide +5V digital and +3.3V analog supplies, respectively. Power supplied directly to JMP1, JMP2 or JMP5 is not filtered; regulated power of the correct voltages must be supplied to these pins.

Physical Description

The board is laid out with separate analog and digital power supplies. Analog power is 5V and is supplied from regulator U1, the USB, or external power connected to JMP1 or JMP5. 3.3V digital power is supplied from regulator U2 or JMP2. When the external power connector J2 is used, it supplies power to regulator U1, which then supplies power to regulator U2.

4 Physical Description

This section contains the schematic drawings, PCB layouts and bill of materials for the MSC1201/02EVM board.

Note:

Board layouts are not to scale. These are intended to show how the board is laid out; they are not intended to be used for manufacturing MSC1201/02EVM PCBs.

4.1 MSC1201/02EVM Schematics

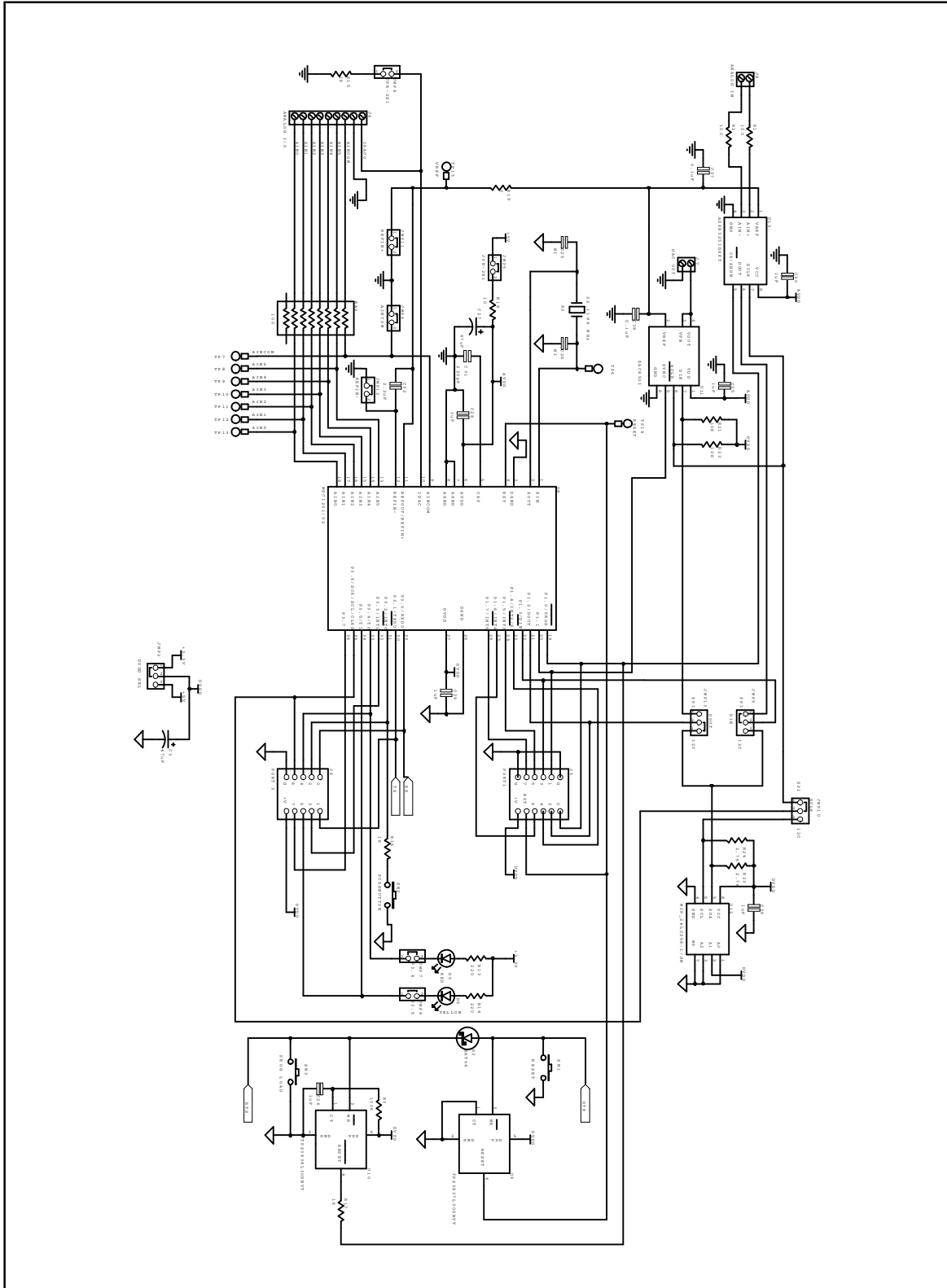

Figure 5. MSC1201/02EVM Processor and Analog Inputs

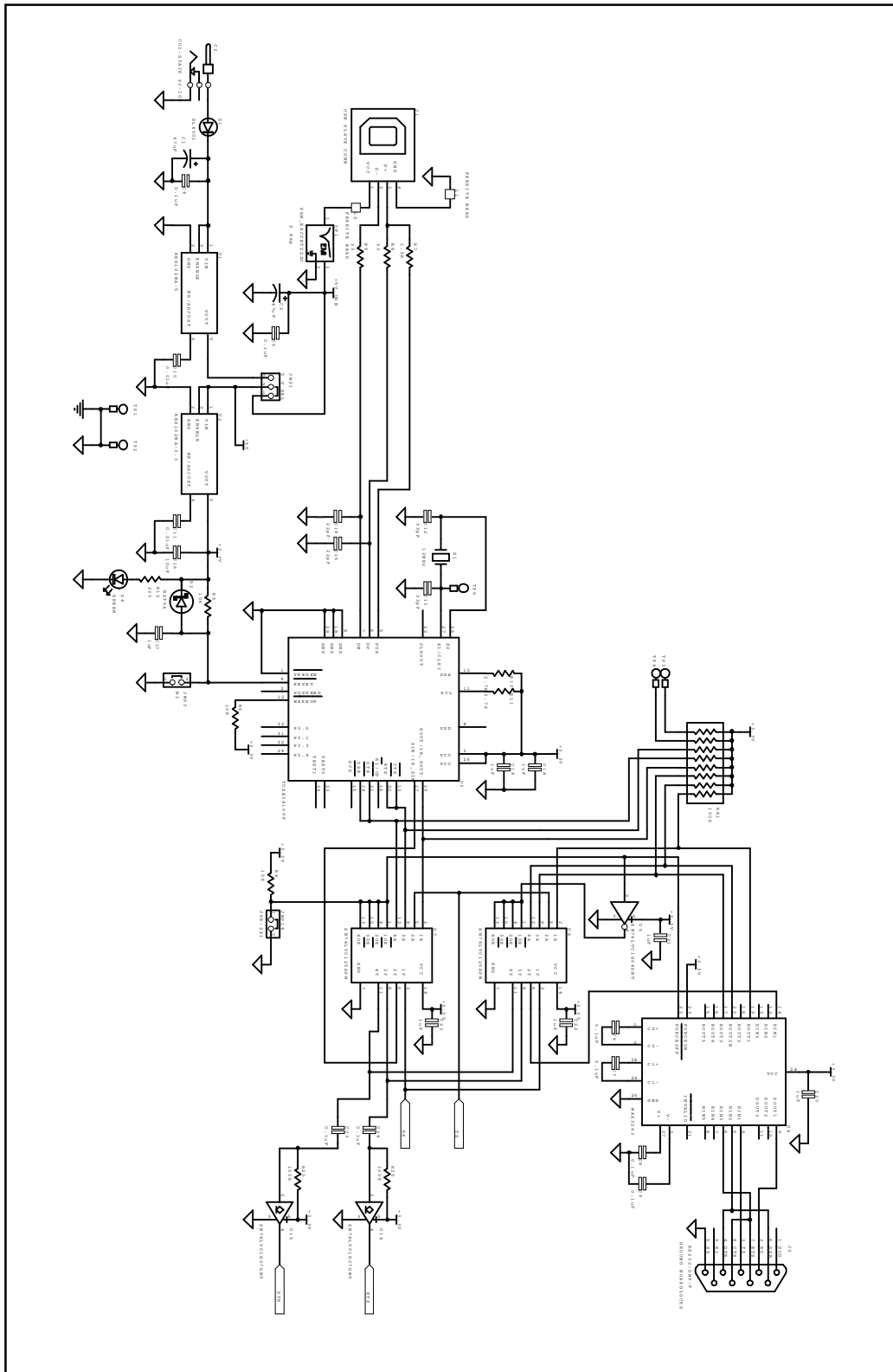

Figure 6. MSC1201/02EVM Power and Communications Selection

4.2 Component Locations

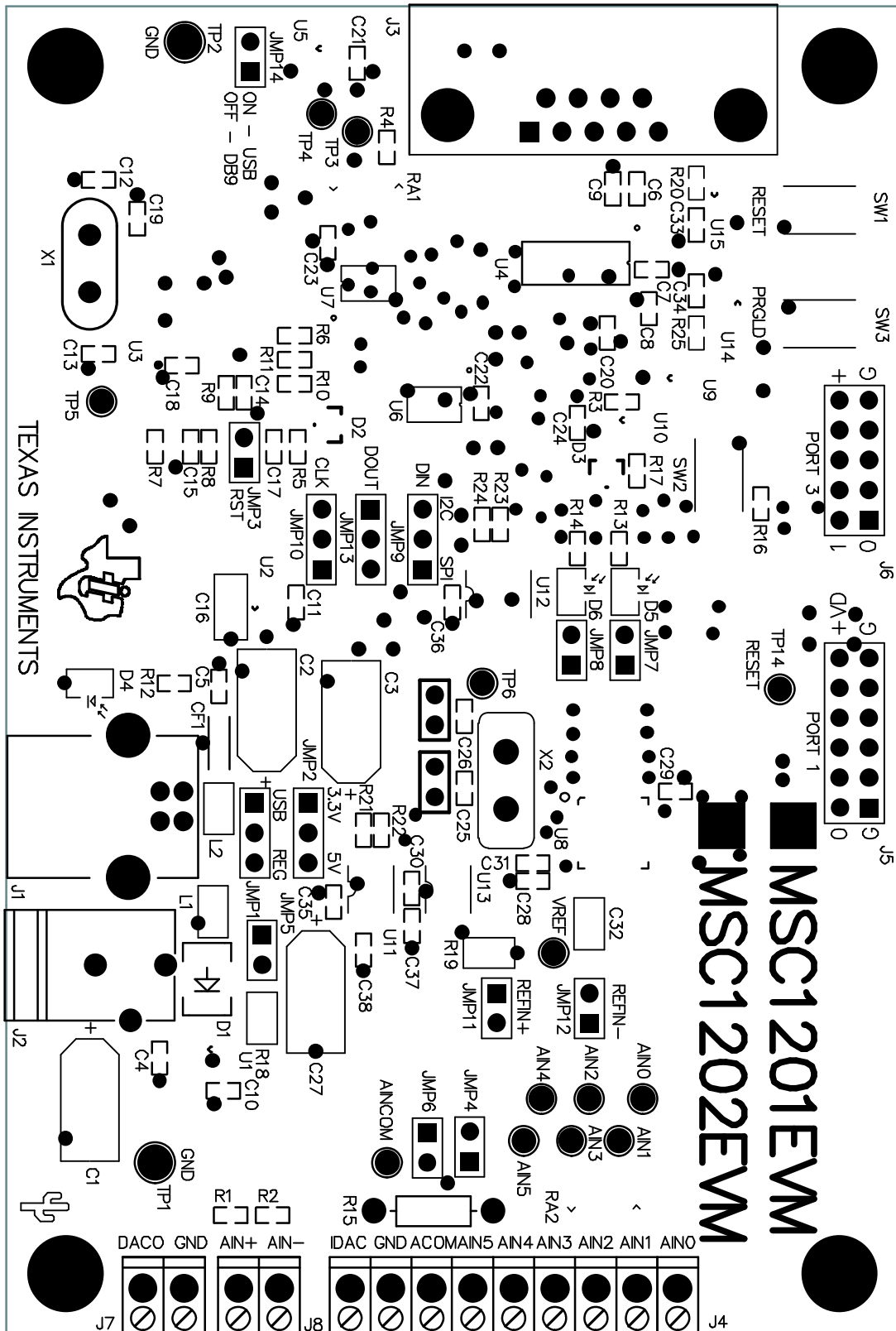

Figure 7. MSC1201/02EVM Layout

4.3 Bill of Materials
Table 11. MSC1201/02EVM Bill of Materials

ITEM NO.	QTY	VALUE	REF. DES.	DESCRIPTION	VENDOR	MFG. PART NUMBER
1	2	0	R20, R27	1/8W 5% Chip Resistor	Panasonic	ERJ-6GEY0R00V
2	1	10	R18	1/8W 5% Chip Resistor	Panasonic	ERJ-6GEYJ100V
3	2	33	R8, R9	1/10W 5% Chip Resistor	Panasonic	ERJ-3GEYJ330V
4	3	100	R19, R25, R26	1/10W 5% Chip Resistor	Panasonic	ERJ-3GEYJ101V
5	1	100	RA2	1/16W 5% Chip Resistor Array	CTS Corporation	742C163101JTR
6	3	220	R12- R14	1/10W 5% Chip Resistor	Panasonic	ERJ-3GEYJ221V
7	2	1K	R16, R17	1/10W 5% Chip Resistor	Panasonic	ERJ-3GEYJ102V
8	1	1K	R15	1/4W 1% Axial Lead Resistor	Yageo	MFR-25FBF-1K00
9	1	1.5K	R7	1/10W 5% Chip Resistor	Panasonic	ERJ-3GEYJ152V
10	4	2.7K	R10, R11, R23, R24	1/10W 5% Chip Resistor	Panasonic	ERJ-3GEYJ272V
11	5	10K	R4-R6, R21, R22	1/10W 5% Chip Resistor	Panasonic	ERJ-3GEYJ103V
12	5	100K	R1-R3, R28, R29	1/10W 5% Chip Resistor	Panasonic	ERJ-3GEYJ104V
13	1	100K	RA1	1/16W 5% Chip Resistor Array	CTS Corporation	742C163104JTR
Not Installed	2	NI (10pF)	C25, C26	50V Ceramic Chip Capacitor, $\pm 0.5\text{pF}$, NPO	TDK	C1608C0G1H100D
14	2	22pF	C14, C15	50V Ceramic Chip Capacitor, $\pm 5\%$, NPO	TDK	C1608C0G1H220J
15	2	33pF	C12, C13	50V Ceramic Chip Capacitor, $\pm 5\%$, NPO	TDK	C1608C0G1H330J
16	1	220pF	C31	50V Ceramic Chip Capacitor, $\pm 5\%$, NPO	TDK	C1608C0G1H221J
17	2	0.01 μF	C10, C11	50V Ceramic Chip Capacitor, $\pm 10\%$, X7R	TDK	C1608X7R1H103K
18	10	0.1 μF	C4-C9, C33, C34, C37, C38	25V Ceramic Chip Capacitor, $\pm 10\%$, X7R	TDK	C1608X7R1E104K
19	14	1 μF	C17-C24, C28-C30, C35, C36, C39	6.3V Ceramic Chip Capacitor, $\pm 10\%$, X5R	TDK	C1608X5R0J105K
20	1	2.2 μF	C32	10V Ceramic Chip Capacitor, $\pm 10\%$, X5R	TDK	C2012X5R1A225K
21	1	10 μF	C16	6.3V Ceramic Chip Capacitor, $\pm 10\%$, X5R	TDK	C3216X5R0J106K
22	4	47 μF	C1-C3, C27	16V Tantalum Chip Capacitor, $\pm 10\%$	Kemet	T491D476K016AS
23	1		CF1	50V, 2200pF EMI Filter	Panasonic	EXC-CET222U
24	1		D1	50V, 1A Diode	Micro Commercial Co.	DL4001
25	2		D2, D3	30V, 200mA Schottky Diode	Fairchild Semiconductor	BAT54
26	1		D4	Green LED	Lumex	SML-LX0603GW-TR
27	1		D5	Red LED	Lumex	SML-LX0603IW-TR

Table 11. MSC1201/02EVM Bill of Materials (continued)

ITEM NO.	QTY	VALUE	REF. DES.	DESCRIPTION	VENDOR	MFG. PART NUMBER
28	1		D6	Yellow LED	Lumex	SML-LX0603YW-TR
29	2		L1, L2	Ferrite Bead Core	Panasonic	EXC-ML20A390U
30	1	12MHz	X1	Quartz Crystal	Citizen	HC49US12.000MABJ
31	1	22.1184 MHz	X2	Quartz Crystal	Citizen	HC49US22.1184MABJ
32	1		U1	5V, 250mA, LDO Regulator	Texas Instruments	REG102NA-5
33	1		U2	3.3V, 250mA, LDO Regulator	Texas Instruments	REG102NA-3.3
34	1		U3	USB/Serial Converter	Texas Instruments	TUSB3410VF
35	1		U4	RS-232 Transceiver	Texas Instruments	MAX3243CPWR
36	1		U5	Single IC Inverter	Texas Instruments	SN74LVC1G04DBVR
37	2		U6, U7	Quad Bus Buffer w/ Tri-State Enable	Texas Instruments	SN74LVC125APW
38	1		U8	Precision ADC/DAC with 8051 Microcontroller	Texas Instruments	MSC120xY3PFBT
39	1		U9	Supervisory Circuit, Reset High	Texas Instruments	TPS3837L30DBVT
40	1		U10	Supervisory Circuit, Reset Low	Texas Instruments	TPS3838L30DBVT
41	1		U11	16-Bit, Digital-to-Analog Converter	Texas Instruments	DAC8531E
42	1		U12	256K I2C EEPROM	Texas Instruments	24LC256-I/SN
43	1		U13	16-Bit, Analog-to-Digital Converter	Texas Instruments	ADS8325IBDGKT
44	2		U14, U15	Single Gate, Open Drain Buffer	Texas Instruments	SN74LVC1G07DBVT
45	1		N/A	MSC12xx EVM PWB	Texas Instruments	xxxxxxx
46	1		J1	USB Type B Socket	Mill-Max	897-30-004-90-000000
47	1		J2	2.5mm Power Jack	CUI Inc.	PJ-102B
48	1		J3	DB9 Right Angle Female Connector	AMP/Tyco Electronics	PJ-102B 747844-4
49	1		J4	11-Position Terminal Block, 3.5mm Spacing	On Shore Technology	ED555/11DS
50	2		J7, J8	2-Position Terminal Block, 3.5mm Spacing	On Shore Technology	ED555/2DS
51	1		J6	5-Position, Dual Row Header, 0.1in Spacing	Samtec	TSW-105-07-L-D
52	1		J5	6-Position, Dual Row Header, 0.1in Spacing	Samtec	TSW-106-07-L-D
53	5		JMP1, JMP2, JMP9, JMP10, JMP13	3-Position Jumper, 0.1in Spacing	Samtec	TSW-103-07-L-S

Table 11. MSC1201/02EVM Bill of Materials (continued)

ITEM NO.	QTY	VALUE	REF. DES.	DESCRIPTION	VENDOR	MFG. PART NUMBER
54	9		JMP3- JMP8, JMP11- JMP12, JMP14	2-Position Jumper, 0.1in Spacing	Samtec	TSW-102-07-L-S
55	3		SW1, SW2, SW3	Normally Open Pushbutton Switch	Panasonic	EVQ-PJU04K
56	2		TP1, TP2	Large Loop Test Point Terminal	Keystone Electronics	5011
57	Not In- stalled		TP3- TP14	Miniature Test Point Terminal	Keystone Electronics	5000
58	14		N/A	Shorting Jumper	Samtec	SNT-100-BK-TH
59	4		N/A	0.25in x 0.625 hex 4-40 Threaded Standoff	Keystone Electronics	1808
60	4		N/A	Pan Head Machine Screws 4-40 x 0.5in Phillips	Building Fasteners	PMS 440 0050 PH

Appendix A Certificate of Conformity

A.1 Wall Mount Power Supply

03-JAN-2000 14:14 VON -FRIWO SALES EXPORT +49-2532-81-112 T-170 P.003/004 F-587

FRIWO Gerätebau GmbH
Von-Liebig-Str. 11
D-48346 Ostbevern
Germany



Wir, der Hersteller, erklären hiermit, daß das Produkt:
We, the manufacturer, hereby confirm, that the product:

Typ: FW 7207/9
Type: FW 7207/9
Zeichnungs-Nr.: Part-No.: 15.0661.500-00
Drawing No.: Part No.: 15.0661.500-00

weitere Merkmale:
additional information:

mit der beiliegenden Beschreibung die Anforderungen der Niederspannungsrichtlinie 73/23/EWG, CE-Kennzeichnungsrichtlinie 93/68/EWG und der EMV-Richtlinien 89/336/EWG, 92/31/EWG erfüllt.
with the enclosed description fulfills the requirements of the Low Voltage Directive 73/23/EEC, CE Marking Standard 93/68/EEC and the regulations of the EMC Directives 89/336/EEC, 92/31/EEC.

Das Gerät entspricht der:
The unit corresponds to:

- | | |
|--|---|
| a) Niederspannungsrichtlinie
<i>Low Voltage Directive</i> | b) EMV-Richtlinie
<i>EMC-Directive</i> |
| <input type="checkbox"/> EN 60742 9/95 | <input checked="" type="checkbox"/> EN 50081-1 3/93 |
| <input type="checkbox"/> EN 60335 5/95 | <input type="checkbox"/> EN 50081-2 3/94 |
| <input checked="" type="checkbox"/> EN 60950 9/94 | <input type="checkbox"/> EN 50082-1 3/93 |
| <input type="checkbox"/> EN 60601 9/94 | <input checked="" type="checkbox"/> EN 50082-2 2/96 |

Ausstellungsdatum:
Date of issue: 98-10-02

Quality Manager ppa. Busche
R & D Manager i.v. Dr. Ebert
checked: R & D Electr. Man. i. V. Schulz

FRIWO Gerätebau GmbH
Von-Liebig-Str. 11
48346 Ostbevern
Firmenstempel Company stamp

FCC Warnings

This equipment is intended for use in a laboratory test environment only. It generates, uses, and can radiate radio frequency energy and has not been tested for compliance with the limits of computing devices pursuant to subpart J of part 15 of FCC rules, which are designed to provide reasonable protection against radio frequency interference. Operation of this equipment in other environments may cause interference with radio communications, in which case the user at his own expense will be required to take whatever measures may be required to correct this interference.

EVM IMPORTANT NOTICE

Texas Instruments (TI) provides the enclosed product(s) under the following conditions:

This evaluation kit being sold by TI is intended for use for **ENGINEERING DEVELOPMENT OR EVALUATION PURPOSES ONLY** and is not considered by TI to be fit for commercial use. As such, the goods being provided may not be complete in terms of required design-, marketing-, and/or manufacturing-related protective considerations, including product safety measures typically found in the end product incorporating the goods. As a prototype, this product does not fall within the scope of the European Union directive on electromagnetic compatibility and therefore may not meet the technical requirements of the directive.

Should this evaluation kit not meet the specifications indicated in the EVM User's Guide, the kit may be returned within 30 days from the date of delivery for a full refund. **THE FOREGOING WARRANTY IS THE EXCLUSIVE WARRANTY MADE BY SELLER TO BUYER AND IS IN LIEU OF ALL OTHER WARRANTIES, EXPRESSED, IMPLIED, OR STATUTORY, INCLUDING ANY WARRANTY OF MERCHANTABILITY OR FITNESS FOR ANY PARTICULAR PURPOSE.**

The user assumes all responsibility and liability for proper and safe handling of the goods. Further, the user indemnifies TI from all claims arising from the handling or use of the goods. Please be aware that the products received may not be regulatory compliant or agency certified (FCC, UL, CE, etc.). Due to the open construction of the product, it is the user's responsibility to take any and all appropriate precautions with regard to electrostatic discharge.

EXCEPT TO THE EXTENT OF THE INDEMNITY SET FORTH ABOVE, NEITHER PARTY SHALL BE LIABLE TO THE OTHER FOR ANY INDIRECT, SPECIAL, INCIDENTAL, OR CONSEQUENTIAL DAMAGES.

TI currently deals with a variety of customers for products, and therefore our arrangement with the user **is not exclusive**.

TI assumes **no liability for applications assistance, customer product design, software performance, or infringement of patents or services described herein.**

Please read the EVM User's Guide and, specifically, the EVM Warnings and Restrictions notice in the EVM User's Guide prior to handling the product. This notice contains important safety information about temperatures and voltages. For further safety concerns, please contact the TI application engineer.

Persons handling the product must have electronics training and observe good laboratory practice standards.

No license is granted under any patent right or other intellectual property right of TI covering or relating to any machine, process, or combination in which such TI products or services might be or are used.

EVM WARNINGS AND RESTRICTIONS

It is important to operate this EVM within the input voltage range of 5.5V to 15V for power input, and 0V to 5V for analog inputs AIN0–AIN7, AINCOM and Analog In, and the output voltage range of 0V to 5V for DACOUT and IDAC.

Exceeding the specified input range may cause unexpected operation and/or irreversible damage to the EVM. If there are questions concerning the input range, please contact a TI field representative prior to connecting the input power.

Applying loads outside of the specified output range may result in unintended operation and/or possible permanent damage to the EVM. Please consult the EVM User's Guide prior to connecting any load to the EVM output. If there is uncertainty as to the load specification, please contact a TI field representative.

During normal operation, some circuit components may have case temperatures greater than 100° C. The EVM is designed to operate properly with certain components above 100° C as long as the input and output ranges are maintained. These components include but are not limited to linear regulators, switching transistors, pass transistors, and current sense resistors. These types of devices can be identified using the EVM schematic located in the EVM User's Guide. When placing measurement probes near these devices during operation, please be aware that these devices may be very warm to the touch.

Mailing Address: Texas Instruments, Post Office Box 655303, Dallas, Texas 75265
Copyright © 2004, Texas Instruments Incorporated

IMPORTANT NOTICE

Texas Instruments Incorporated and its subsidiaries (TI) reserve the right to make corrections, modifications, enhancements, improvements, and other changes to its products and services at any time and to discontinue any product or service without notice. Customers should obtain the latest relevant information before placing orders and should verify that such information is current and complete. All products are sold subject to TI's terms and conditions of sale supplied at the time of order acknowledgment.

TI warrants performance of its hardware products to the specifications applicable at the time of sale in accordance with TI's standard warranty. Testing and other quality control techniques are used to the extent TI deems necessary to support this warranty. Except where mandated by government requirements, testing of all parameters of each product is not necessarily performed.

TI assumes no liability for applications assistance or customer product design. Customers are responsible for their products and applications using TI components. To minimize the risks associated with customer products and applications, customers should provide adequate design and operating safeguards.

TI does not warrant or represent that any license, either express or implied, is granted under any TI patent right, copyright, mask work right, or other TI intellectual property right relating to any combination, machine, or process in which TI products or services are used. Information published by TI regarding third-party products or services does not constitute a license from TI to use such products or services or a warranty or endorsement thereof. Use of such information may require a license from a third party under the patents or other intellectual property of the third party, or a license from TI under the patents or other intellectual property of TI.

Reproduction of information in TI data books or data sheets is permissible only if reproduction is without alteration and is accompanied by all associated warranties, conditions, limitations, and notices. Reproduction of this information with alteration is an unfair and deceptive business practice. TI is not responsible or liable for such altered documentation.

Resale of TI products or services with statements different from or beyond the parameters stated by TI for that product or service voids all express and any implied warranties for the associated TI product or service and is an unfair and deceptive business practice. TI is not responsible or liable for any such statements.

Following are URLs where you can obtain information on other Texas Instruments products and application solutions:

Products		Applications	
Amplifiers	amplifier.ti.com	Audio	www.ti.com/audio
Data Converters	dataconverter.ti.com	Automotive	www.ti.com/automotive
DSP	dsp.ti.com	Broadband	www.ti.com/broadband
Interface	interface.ti.com	Digital Control	www.ti.com/digitalcontrol
Logic	logic.ti.com	Military	www.ti.com/military
Power Mgmt	power.ti.com	Optical Networking	www.ti.com/opticalnetwork
Microcontrollers	microcontroller.ti.com	Security	www.ti.com/security
		Telephony	www.ti.com/telephony
		Video & Imaging	www.ti.com/video
		Wireless	www.ti.com/wireless

Mailing Address: Texas Instruments
Post Office Box 655303 Dallas, Texas 75265